

Catalog # :

Project :

Prepared By :

Date :



SDL4' LED Strip Diffused Lens

The sleek architectural SDL is designed with toolless entry features saving time and money on installation. Optimizing industry leading LED technology, the SDL series delivers unparalleled performance and efficiency meeting stringent energy requirements. The frosted lens delivers high vertical illumination offering 3000K, 3500K, 4000K and 5000K color temperatures. Innovative programmable drivers offer expansive lumen packages and comes standard with 0-10V dimming down to 1%. Designed with uncompromised aesthetics, the high-performance luminaire is well suited for commercial, industrial, retail and residential applications.

Features & Specifications

Optical System

- High transmission custom extruded frosted acrylic radius lens eliminates bright spots from individual LED's and provides high vertical illumination and visual comfort.
- Use of closely spaced medium-power, high brightness chips minimizes pixilation and provides uniform lens luminance.
- Available in 5000K, 4000K, 3500K, and 3000K color temperatures per ANSI C78.377. Consult Factory for other color temperature requirements.
- Minimum CRI of 80.

Electrical

- Class 2 high-performance programmable driver features short circuit, open circuit protection for LED + and LED - and temperature foldback. Driver complies with FCC standards.
- 0-10 volt dimming (1% - 100%) standard.
- Standard Universal voltage (120-277 Vac) Input 50/60 Hz. Optional high Voltage 347 Vac Input available, consult factory for lead time and DLC® qualification information. Not all versions of this product may be DLC qualified. Please check the DLC Qualified Products List at www.designlights.org/QPL to confirm which versions are qualified.
- L70 Calculated Life: >60k Hours @ 25°C per IESNA TM-21-11. (See Lumen Maintenance on Page 2)
- Total harmonic distortion: <20%
- Power factor: >.90
- Input power stays constant over life.
- Optional (120-277V) integral 10 watt battery backup is available. The 90-minute batteries provide constant power to the LED system. The fixture delivers 1300 lumens during emergency mode. A test switch/indicator button is installed in the housing for ease of maintenance.

Controls

- Optional Bolt-on integral passive infrared motion and/or daylight sensor activates switching of luminaire light levels (see page 5 for more details).
- Optional Step-level dimming driver allows system to be switched to 50% power for compliance with common energy codes while maintaining fixture appearance.



Dimensions

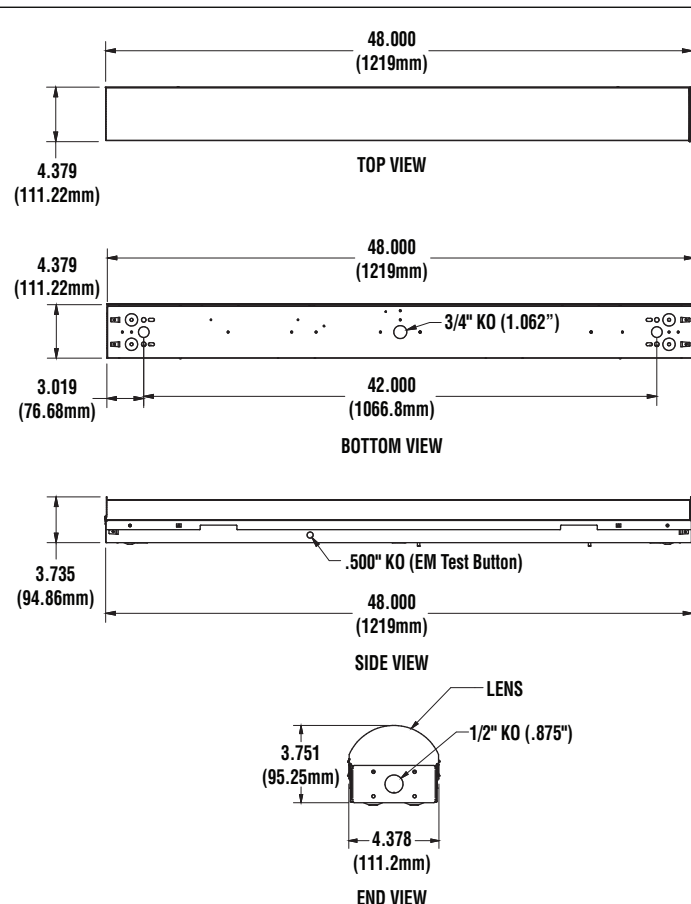



Features & Specifications (cont.)

Construction

- Rigid housing is die-formed 22-gauge cold rolled steel for consistency and strength.
- Available for individual or continuous row mounting.
- Tool-less access by applying pressure/squeezing the ends of the electrical housing channel to remove the lens/light engine assembly to access the wireway chamber
- Luminaire is proudly manufactured in the U.S of U.S. and imported components.
- Luminaire is painted after fabrication following treatment with phosphate rust inhibitor. Finish coat of housing is high reflectance white (minimum 92%) polyester powder.
- Shipping weight: 9 lbs

Installation

- Suitable for surface, pendant, grid and chain mounting.
- Accepts optional plug-in wiring feature for continuous row installation.
- Alignment couplers furnished for continuous row installation.

Warranty

- LSI LED Fixtures carry a 5-year warranty.
- 1 Year warranty on optional Battery Backup. Test regularly in accordance with local codes.

Listing

- Listed to UL 1598 and UL 8750 for 25°C Ambient applications
- RoHS Compliant.
- State of California Title 24 compliant with OCSUE/DHSUE option.
- American Recovery and Reinvestment Act Funding Compliant.
- Suitable For Damp Locations.

Photometry

- See website for IES and photometric files

Performance

SDL4 ELECTRICAL DATA (Amps)*				
Lumen Package	120V	208V	240V	277V
20L	0.13A	0.07A	0.06A	0.05A
30L	0.19A	0.11A	0.09A	0.08A
40L	0.25A	0.14A	0.13A	0.11A
50L	0.32A	0.18A	0.16A	0.14A
60L	0.37A	0.21A	0.18A	0.16A
70L	0.44A	0.25A	0.22A	0.19A
80L	0.51A	0.29A	0.26A	0.22A

*Electrical data at 25C (77F). Actual wattage may differ by +/-10%.

Recommended Lumen Maintenance ¹						
LUMENS	AMBIENT TEMP C	INITIAL ²	25K HR ²	50K HR ²	75K HR ³	100K HR ³
40L	25C	99%	97%	95%	94%	92%
80L	25C	98%	96%	93%	91%	89%

Specifications and dimensions subject to change without notice.

- 1 - Lumen maintenance values at 25C are calculated per TM-21 based on LM-80 data and in-situ testing.
- 2 - In accordance with IESNA TM-21-11, Projected Values represent interpolated value based on time durations that are within six times the IESNA LM-80-08 total test duration for the device under testing
- 3 - In accordance with IESNA TM-21-11, Calculated Values represent time durations that exceed six times the IESNA LM-80-08 total test duration for the device under testing

*LED chips are frequently updated therefore values are subject to change.



Performance (cont.)

SDL4 DELIVERED LUMENS*										
LUMEN PACKAGE	CRI	3000K CCT		3500K CCT		4000K CCT		5000K CCT		WATTAGE
		DELIVERED LUMENS	EFFICACY	DELIVERED LUMENS	EFFICACY	DELIVERED LUMENS	EFFICACY	DELIVERED LUMENS	EFFICACY	
20L	80	1947	120.3	2015	132.6	2009	132.2	2148	140.4	15.2
30L	80	2930	125.5	3041	134.6	3032	134.2	3242	143.4	22.6
40L	80	3879	128.9	4026	133.8	4014	133.4	4292	142.6	30.1
50L	80	4833	125.9	5017	130.6	5002	130.3	5348	139.3	38.4
60L	80	5815	132.5	6036	137.5	6018	137.1	6434	146.6	43.9
70L	80	6788	130.3	7046	135.2	7025	134.8	7511	144.2	52.1
80L	80	7776	127.1	8072	131.9	8048	131.5	8605	140.6	61.2

*LED chips are frequently updated therefore values are subject to change.



SDL4' LED Strip Diffused Lens

Luminaire Ordering Guide

TYPICAL ORDER EXAMPLE: **SDL4 LED 40L FL UNV DIM1 35 80CRI**

Family Size	LED Gen	Lumen Package	Lens	Voltage	Driver	Color Temp	CRI	Controls	Options	Packaging	
SDL4 - 4' Strip	LED	20L - 2000	FL Frosted Lens	UNV - 120-277V 347 - 347V ¹	DIM1 - Dims to 1%(0-10V) SD50 - Step dimming to 50% ²	30 - 3000K 35 - 3500K 40 - 4000K 50 - 5000K	80CRI - 80 CRI	(Blank) - None OCSUE - Occupancy Sensor 120-277V ² DHSUE - Daylight harvesting/Occupancy Sensor 120-277V ²	(Blank) - None EM10 - 10W Battery Backup (1300 Lumens) ² PM1 - 5FT Pre-wired plug in assembly (standard) ² PM1LV - 5FT Pre-wired plug in assembly (0-10V Dimming) ² PM2 - 5FT Pre-wired plug in assembly (SD50 or EM10) ² PM2LV - 5FT Pre-wired plug in assembly (SD50 or EM10 with 0-10V Dimming) ²	(Blank) - Single Pack	
		30L - 3000									40L - 4000
		*Consult factory for programmable wattages and lumen packages									

NOTES:

1. Consult factory for leadtime & DLC qualifications.
2. Not available with 347V

Accessory Ordering Information (Accessories are field installed)

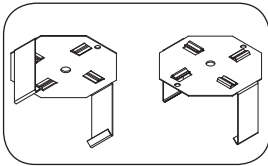

Description: T-Grid Hanger Kit
Order Number: (Qty 2) - 671560

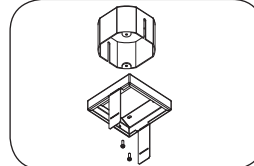

Description: T-Grid Collar (including junction box, wire collar & grid hanger)
Order Number: (Qty 1) - 558651

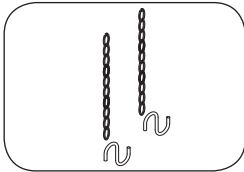

Description: Chain Hanger Set (36" length)
Order Number: (Qty 2) - M38258

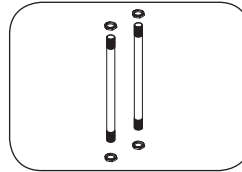

Description: 24" Pendant
Order Number: (Qty 1) - 687400

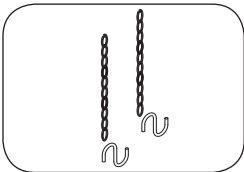

Description: Chain Hanger Set (60" length)
Order Number: (Qty 2) - 251057

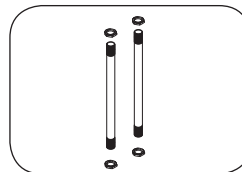

Description: 36" Pendant
Order Number: (Qty 1) - 681509

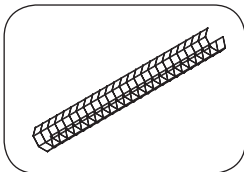

Description: Wire Guard - 4 foot
Order Number: (Qty 1) - 549301

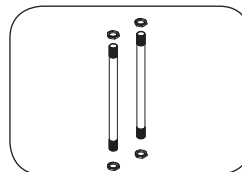

Description: 48" Pendant
Order Number: (Qty 1) - 687382



Controls

Occupancy Sensor (OCSUE)

- Optional integral passive infrared motion activates switching of luminaire on/off. Standard Factory settings: Luminaire is activated and increased to full bright upon detection of motion. Luminaire powers off when target zone is absent of motion activity for ~5 minutes. See coverage diagram for detection cone.

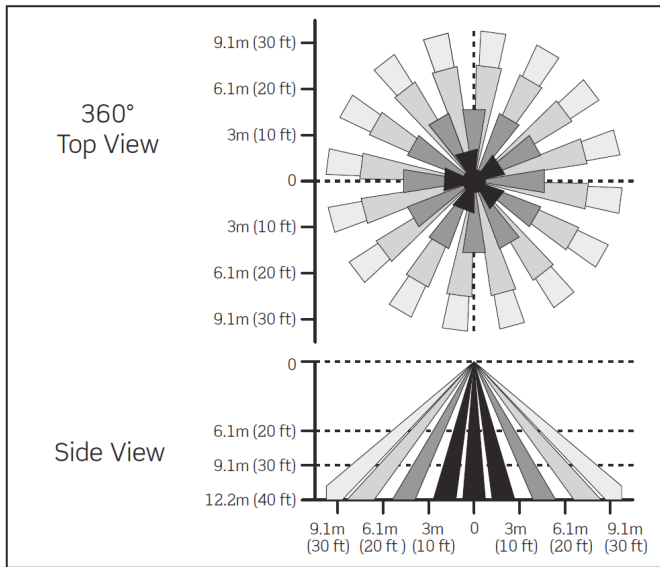

Occupancy Sensor / Daylight Sensor (DHSUE)

- Optional integral passive infrared motion and daylight sensor activates switching of luminaire on/off. Standard Factory settings: Luminaire is activated and increased to full bright upon detection of motion. Luminaire powers off when target zone is absent of motion activity for ~5 minutes. See coverage diagram for detection cone. Photocell turns off lights when sufficient amount of daylight is detected and turns lights on when additional lighting is required.

